

8CH. Duplex Video Multiplexer

M80CE --- Color

M80BE --- B &W

USER'S MANUAL



1	2	3
4	10/01/02 10:00:00	5
6	7	8

CAM 1			2
			3
10/01/02		10:00:00	4
5	6	7	8

Safety Precautions

TO PREVENT FIRE OR ELECTRIC SHOCK, DO NOT EXPOSE THIS PRODUCT TO RAIN OR MOISTURE.

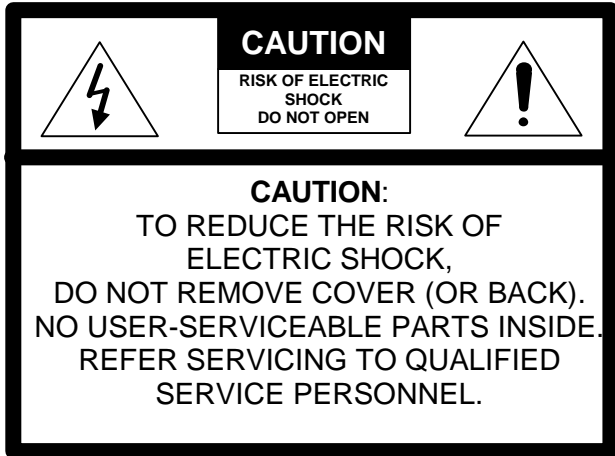

ATTENTION:

POUR EVITER LES CHOCS ELECTRIQUES, INTRODUIRE LA LAME LA PLUS LARGE DE LA FICHE DANS LA BORNE CORRESPONDANTE DE LA PRISE ET POUSSER JUSQU'AU FOND.



This symbol is intended to alert the user to the presence of un-insulated “dangerous voltage” within the product’s enclosure that may be of sufficient magnitude to constitute a risk of electric shock to persons.



This symbol is intended to alert the user to the presence of important operating and maintenance (servicing) instructions in the literature accompanying the appliance.

Operating Safety

- ?? Use only the factory supplied (5VDC 3.0A) power adapter to operate the system.
- ?? Do not try to force the system’s plug into a power outlet. It has one blade that is wider than the other for safety purposes.
- ?? If any liquid or solid object falls into the cabinet, unplug the system and have it checked by a qualified technician before operating it again.
- ?? Do not block the ventilation opening. The openings keep the system from overheating.
- ?? Do not install the system in a hot or humid place, or where there is excessive dust or vibration.

Owner’s Record

The model and serial numbers are located at the bottom of the system. Record these numbers in the spaces provided below. Refer to them whenever you call technical support regarding this product.

Model Number: _____

Serial Number: _____

FCC Compliance Statement

User/Installer Caution: Your authority to operate this FCC verified equipment could be voided if you make changes or modifications not expressly approved by the party responsible for compliance to Part 15 of the FCC rules.

This digital apparatus does not exceed the Class A limit for radio noise emissions from digital apparatus set out in the radio interference regulations of Canada.

Note: this equipment has been tested and found to comply with the limits for a Class A digital device, pursuant to Part 15 of the FCC rules. These limits are designed to provide reasonable protection against harmful interference when the equipment is operated in a commercial environment. This equipment generates, uses, and can radiate radio frequency energy and if not installed and used in accordance with the instruction manual, may cause harmful interference to radio communications. Operation of this equipment in a residential area is likely to cause harmful interference that the user will be required to correct at his or her own expense.

Contents

Safety Precautions	1
FCC Compliance Statement	2
System Controls and Connectors	4
Front Panel Controls	4
Back Panel Connectors	5
Basic System Setup	6
Basic Operations	7
Full-Screen / Quad Modes	7
Video Switching Mode	7
VCR Playback Mode	8
2X Zoom Display Mode	8
	9
System Configuration	10
Understanding Menu Buttons	10
Main Menu	10
Dwell Time	11
Alarm Settings	12
Display – Date & Time Settings	13
Clock / Camera ID	14
Record Mode	15
Factory Default	16
	17
VCR Playback	18
VCR Playback mode	18
Bypass Mode	18
	19
Alarm Setup	20
Alarm Setup and Installation	20
Typical Alarm Configuration	20
	21
Specifications	22

System Controls and Connectors

Front Panel Controls

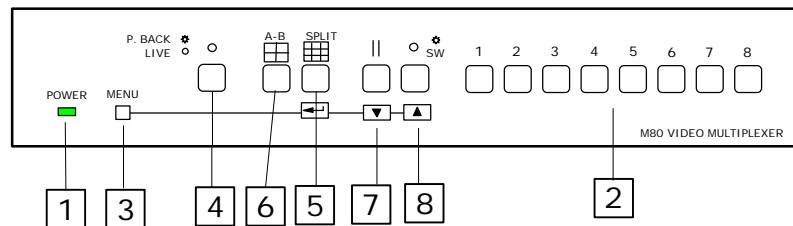

1. **Power Indicator** p.7
Shows whether the M80CE/BE is on or off.
2. **Video Selector** p.7
Selects a camera input to be displayed in full-screen mode to the main monitor output.
3. **MENU Button** p.10
The M80CE/BE will enter user setup mode.
4. **P. BACK/LIVE Button** p.8
Connects the VCR (VCR IN) to the main monitor for playback. This button does not affect the VCR output (VCR OUT) during duplex operation.
5. **SPLIT Button** p.7
Selects 3x3 screen mode in M80CE/BE model.
ENTER Button p.8
This button acts as the **ENTER** button while in user setup mode.
6. **A-B Button** p.7
Selects quad screen mode in M80CE/BE model.
7. **|| Button** p.7
Freezes the image on the main monitor, or returns to normal video.
Function p.8
This button provides down navigation while in user setup mode.
8. **SW Button** p.8
Selects the full screen switch mode on the main monitor.
Function p.8
This button provides up navigation while in user setup mode.

System Controls and Connectors

Back Panel Connectors

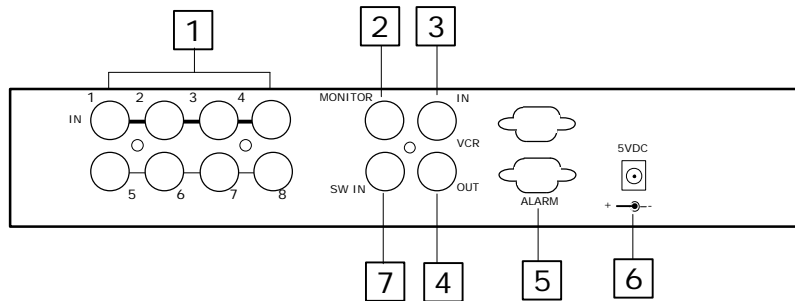

1. Video Input

Connects to the video output of up to 8 cameras for M80CE/BE.

2. Main Monitor Output

Connects to the video input of a video monitor.

3. VCR Input

Connects to the video output of a VCR or time-lapse recorder.

4. VCR Output

Connects to the video input of a VCR or time-lapse recorder.

5. Alarm Input/Output

Connects to the alarm input sources and output targets.

6. Power Input

Connects to the factory supplied AC/DC power adapter.

7. SW IN

Connects to the SW OUT of a time-lapse recorder.

Basic System Setup

Typical System Configuration Diagram

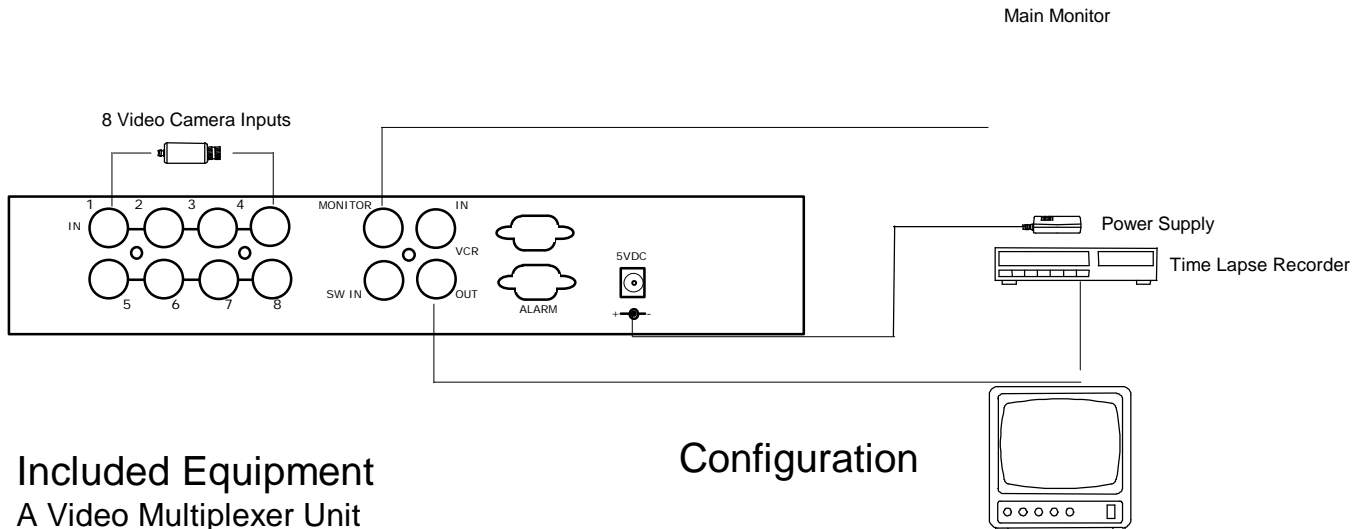

Included Equipment

- ?? A Video Multiplexer Unit
- ?? AC/DC Power Supply
- ?? User's Manual
- ?? AC Power Cord

Recommended Equipment

- ?? Video Monitor
- ?? Video Tape Recorder
- ?? Video Cameras
- ?? Coaxial BNC Cables

Configuration

Video Cameras

Connect up to 8 cameras and to the 8 video inputs using coaxial cable.

Main Monitor

Connect the main monitor output with the video input connector on a video monitor using coaxial cable.

Video Tape Recorder

Connect the VCR input with the video output on a VCR or a time-lapse tape recorder using coaxial cable.
Connect the VCR output with the video input on a VCR or a time-lapse tape recorder using coaxial cable.

Power Supply

Connect the factory supplied AC power supply with the DC plug on the M80CE/BE and an AC power outlet.

Basic Operations

Basic Buttons

Power Indicator

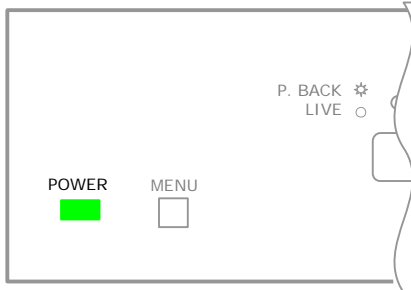

Power Indicator Lamp

Glowing = Power On

To turn power on, plug the power supply into an AC power outlet and connect the DC plug to the M80CE/BE.

Dark = Power Off

To turn the power off, disconnect the power supply from the M80CE/BE.

Caution: Make sure the power is off when connecting cameras, monitors, an alarm sensor and VCR.

Full-Screen Mode Video Selector



Full-Screen Mode

To select a desired camera input to be displayed, press the button number corresponding to the camera's number. For example, press button 2 to display the input from camera 2 on the main monitor.

QUAD/SPLIT Buttons

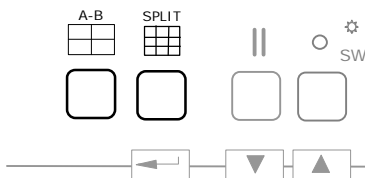

Quad Mode

Quad page A or B will be displayed by pressing the  button from any full-screen or full-screen switching mode to display 4 cameras at a time on the main monitor.

II (Pause) Buttons

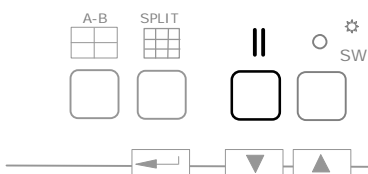

Split Mode

3x3 or 8 split mode will be displayed by pressing the  button from any full-screen or full-screen switching mode to display all 8 cameras on the main monitor.

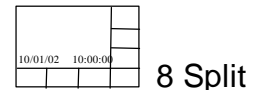
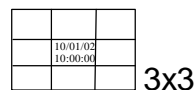

Pause Mode

Press the  button from Quad mode, full-screen, or full-screen switching mode to pause (freeze) the image on the main monitor.

SW Buttons

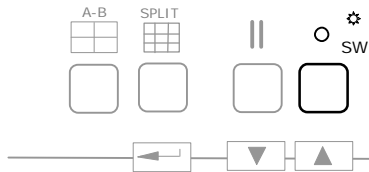

PLAYBACK/LIVE Button

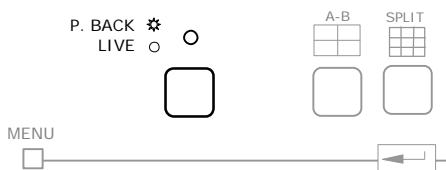

MENU Function

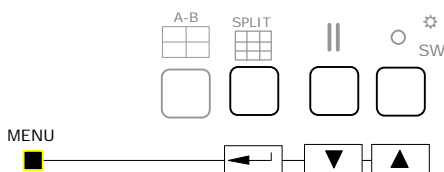

Video Switching Mode

For activating Full-Screen Switching, Press the SW button while the screen is in full-screen mode.

VCR Playback Mode

Entering VCR Playback Mode

Press the P.BACK/LIVE button from any video mode to display the VCR input (VCR IN) on the main monitor. The VCR output is not affected.

Returning to Live Mode

Press the P.BACK/LIVE button from VCR playback mode to return to the mode prior to VCR playback mode.

User Setup Mode

User Setup Mode Description

The user setup menu allows to program of various system options with a simple on screen display. Three buttons are used to select and modify menu options.

Entering User Setup Menu

Press the MENU from any live video mode to display the main setup menu on screen.

Exiting User Setup Menu

Press the MENU button while in the user setup menu to exit the user setup menu.

Note: The alarm will not operate while the M80CE/BE is in user setup mode.

2x Zoom Display Mode

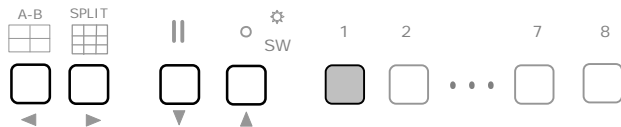
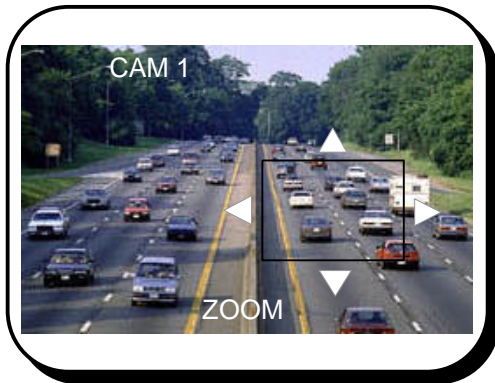

Menu Buttons

Select a desired full screen (ex. CH1) and press CH1 button for 2~3 seconds, a small window and ZOOM will appear on the screen as shown in picture.



These buttons move the window to the left, right, down and up.

Move the window to the target position using the above buttons.

Then press CH1 button. A small window area will be displayed into the full size of the monitor screen. (Approx. 2X zoom)

Press Freeze (||) button on the zoom screen, it will be paused and display ZOOM --) FREEZE in the center of the bottom.

To release the zoom screen, press CH1 button.

Menu Buttons

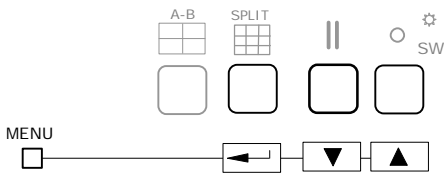

Menu Buttons

While the setup menu is displayed, three buttons become menu navigation controls. The alternate functions of these three buttons are marked below the buttons as shown on the diagram.

(Left/Down) Function

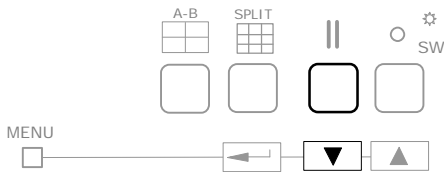

(Left/Down) Function

This button moves the cursor to the left or down. When an item is selected, this button changes (or decreases) the value of the selected item.

(Right/Up) Function

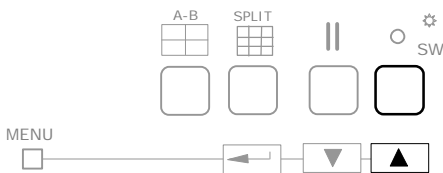

(Right/Up) Function

This button moves the cursor to the right or up. When an item is selected, this button changes (or increases) the value of the selected item.

(ENTER) Function

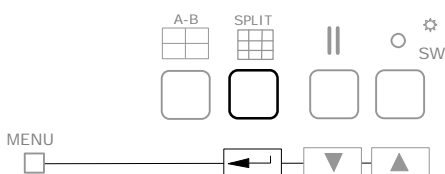

(ENTER) Function



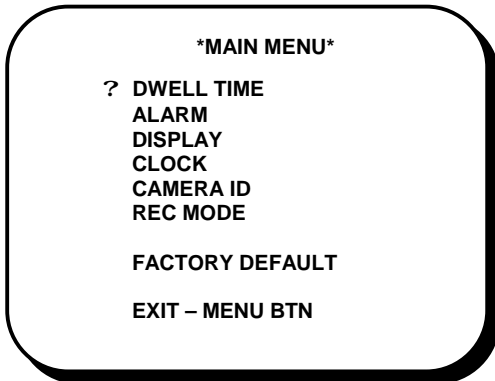

This button selects the item that is currently pointed to by the cursor. If this button is pressed while an item is selected, the current value and setting will be saved. To discard the changes, press the MENU button instead of the ENTER button.

Main Menu



The MAIN MENU is the first screen you will see when the MENU button is pressed. The currently selected sub-menu is denoted with a “?” on the left of the sub-menu item.

Advancing to a Sub-Menu

- 1 Use the  or  button to move the cursor to the item of interest. Look for these menu symbols below the buttons.
2. Select the item using the  button. The  button acts as the  button when the M80CE/BE is not in user setup mode.
3. A new sub-menu screen will appear.

Press the MENU button to exit the MAIN MENU.

DWELL TIME p.12

Sets the number of seconds the M80CE/BE will stay (dwell) on each camera when in Full Screen video switching mode.

ALARM p.13
Enables or disables the alarm inputs and configures alarm trigger actions.

DISPLAY p.14
Allows configuration of the various on-screen displays of the date, time, and camera identification.

CLOCK p.15
Allows current time and date to be set.

CAMERA ID p.15
Allows each camera to be given an identification name of up to 12 characters per camera.

REC MODE p.16
Allows the M80CE/BE to receive a (SW OUT) trigger from a Time Lapse Recorder.

FACTORY DEFAULT p.17
Reset all system values to the factory default values.







DWELL TIME

CAMERA	TIME
1	03 SEC
2	03 SEC
3	03 SEC
4	03 SEC
5	03 SEC
6	03 SEC
7	03 SEC
8	03 SEC
RETURN	

EXIT-MENU BTN

The M80CE/BE is capable of allowing each camera's dwell time to be set independently.

Changing Dwell Time

1. Select DWELL TIME from the MAIN MENU.
Move the cursor to the camera whose dwell time is to be changed using the  or  button.
 1. Select the camera to be changed using the  button.
3. Press the  button to decrease or the  button to increase the dwell time to the desired time.
4. Save the setting by pressing the  button.

You may repeat steps two through four above for each camera that requires changes to dwell time.

Alarm Settings

CAMERA	ALARM
1	ON
2	ON
3	ON
4	ON
5	ON
6	ON
7	ON
8	ON
TIME	30 SEC
BEEP	ON
VIDEO	ON

RETURN
EXIT- MAIN BTN

Each alarm input to the M80CE/BE can be configured independently.

Changing Alarm Settings

1. Select ALARM from MAIN MENU.
2. Use the or button to move the cursor to the camera whose alarm setting is to be changed.
3. Select the desired camera using the button.
4. Press or button to change the alarm setting.
5. Save the setting by pressing the button.

You may repeat steps two through five above for each camera that requires changes to the alarm set up.

Available Alarm Settings

- OFF** Alarm is off, so the M80CE/BE will not respond to the alarm inputs.
- ON** Alarm is on, so the M80CE/BE will respond to the alarm inputs.
- TIME** Press the or button to change the alarm time, 1 through 60 Sec.
- BEEP** The M80CE/BE will sound an alarm, a beeping noise, to alert when it is triggered by an alarm input.
- VIDEO** The M80CE/BE will display “-A-” on the affected camera on both the MAIN MONITOR and the VCR OUT when it is triggered by an alarm input.

Display Settings

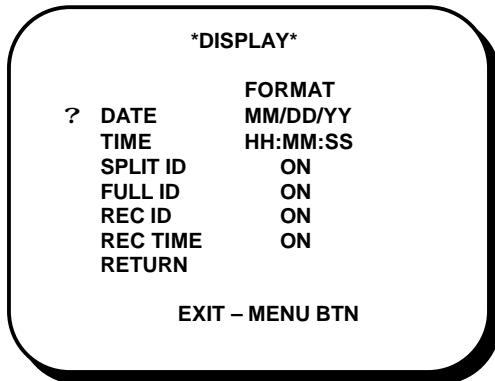

Changing Display Settings

1. Select DISPLAY from the MAIN MENU.
2. Use the or button to move the cursor to the item whose setting is to be changed.
3. Select the item using the button.
4. Use the or button to change the setting.
5. Save the setting by pressing the button.

Available Date Settings

OFF	No date information is displayed.
MM/DD/YY	Month/Day/Year
DD/MM/YY	Day/Month/Year
DD/MM	Day/Month

Available Time Settings

OFF	No time information is displayed.
HH:MM	Hour:Minute
HH:MM:SS	Hour:Minute:Second

SPLIT ID Enable or disable the display of the camera number in split-screen mode.

FULL ID Enable or disable the display of camera identification in the full-screen or full-screen switching modes.

REC ID Enable or disable the display of camera identification in VCR recording.

REC TIME Enable or disable the display of the date and time in VCR recording.

System Clock

CLOCK

? DATE	10/01/02 (MM/DD/YY)
TIME	00:00:00 (HH:MM:SS)
RETURN	
EXIT-MENU BTN	

Camera ID

CAMERA ID

CAMERA	ALARM
1	CAM 1
2	CAM 2
3	CAM 3
4	CAM 4
5	CAM 5
6	CAM 6
7	CAM 7
8	CAM 8
RETURN	
EXIT-MENU BTN	

Setting the Current Date and Time

1. Select CLOCK from the MAIN MENU.
2. Use the or button to move the cursor to the DATE or TIME whose setting is to be changed.
3. Select the item using the button.
4. The currently selected field will blink.
5. Press the or button to change the value.
6. Confirm the setting by pressing the button. The cursor will automatically advance to the next field.
7. Repeat steps 4 and 5 until the last field is reached.

The new settings will be saved, and they will take effect when the last field is entered.

The M80CE/BE provides up to seven characters for camera identification.

Changing the Camera ID

1. Select CAMERA ID from the MAIN MENU.
2. Use the or button to move the cursor to the camera whose identification is to be changed.
3. Select the desired camera using the button.
4. The currently selected field will blink.
5. Press the or button to change the character.
6. Confirm the settings by pressing the button. The cursor will automatically advance to the next field.
7. Repeat steps five and six until the last field is reached.

The new settings will be saved and will take effect when the last field is entered.

Record Mode

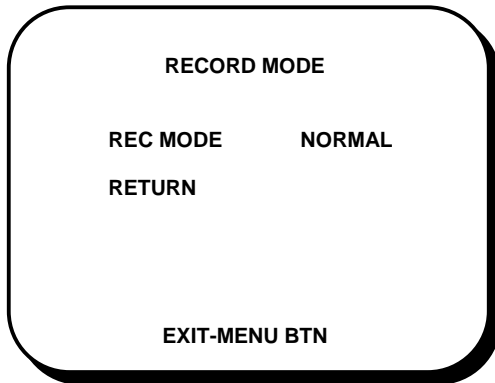





NORMAL

Most Time Lapse Recorders will work in NORMAL mode.

TRIGGER

This mode is used with Time Lapse Recorders that can supply the Camera switching timing control signals to the M80CE/BE. These Recorders will have a (SW OUT) connector, which should be cabled to the (SW IN) connector on the M80CE/BE.

Setting the Record Mode

1. Select RECORD MODE from the MAIN MENU.
2. Select RECORD MODE using the  button.
3. The currently selected field will blink. Press the  or  button to change the setting.
4. Confirm the setting by pressing the  button.

Factory Default

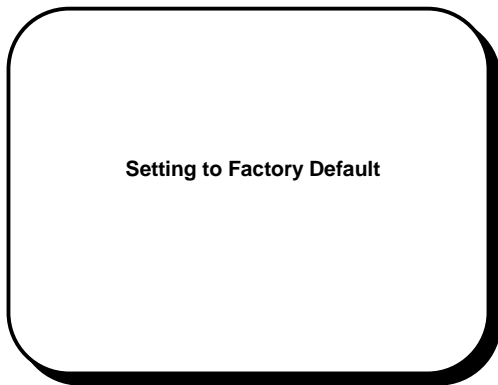

Resetting System Values to Factory Defaults

1. Move the cursor to FACTORY DEFAULT in the MAIN MENU.
2. Select FACTORY DEFAULT by pressing the  button.
3. The menu screen will disappear momentarily and then reappear. When this is complete, the factory default settings are restored.

Date and time settings will not be affected by execution of factory default.

VCR Playback

PLAYBACK Button

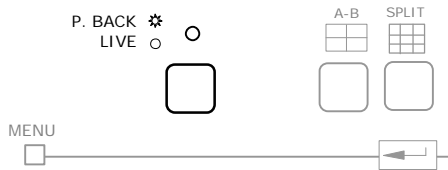

VCR Playback Mode

Enabling VCR Playback

Press the P.BACK/LIVE button from any video mode. The VCR input (VCR IN) will be displayed on the main monitor. The VCR output will not be affected.

Returning to Live Mode

Press the PLAYBACK/LIVE button while in VCR playback mode. The mode prior to VCR playback mode will be restored.

Note: The MENU button in VCR playback mode will select a VCR bypass (see p.18).

QUAD/SPLIT Mode



Quad/Split Mode

Press the   button from any full-screen or full-screen switching mode to display 4 or 8 cameras at a time on the main monitor.

Full-Screen Mode



Full-Screen Mode

To select a desired camera input to be displayed full screen, press the button number corresponding to the camera's number.

For example, press button 2 to display camera 2 on the main monitor.

Bypass Mode

The M80CE/BE has a unique feature that allows the monitoring of VCR input without de-multiplexing. This feature is useful for verifying correct operation of the VCR output and for diagnosing VCR playback related problems.

Entering Bypass Mode

While in VCR playback mode, press the MENU button.

Monitoring VCR Recording

By entering VCR bypass mode, the actual video images being recorded by the M80CE/BE can be monitored. Due to the fact that the M80CE/BE records 8 cameras at once by switching rapidly from one camera to the next, the video images displayed in this mode may not be recognizable. This is normal.

Diagnosing VCR Playback Problems

Most VCR playback problems arise because of improper system installation or because of VCR problems. By entering VCR bypass mode, the video images recorded by the VCR can be observed.

VCR Menu Setup

The video signal generated by VCR in the VCR setup menu may not be recognized by the de-multiplexing circuitry of M Series. To view video produced by the VCR setup menu, use VCR bypass mode.

Alarm Setup

Alarm Setup and Installation

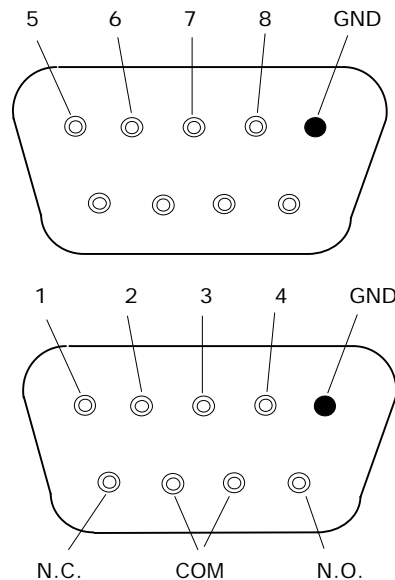

The M80CE/BE provides an interface to external alarm inputs and outputs through 9-pin D-SUB connectors on the rear panel. Authorized dealers supply a mating connector to this for the M80CE/BE.

Pin Definitions

- 1 to 8** Alarm Inputs for each corresponding camera. Only normally open type alarm devices are supported.
- GND** Ground should be connected to the ground reference of the alarm detection device.
- N.O.** Normally Open alarm relay output. This can be connected to a VCR or time-lapse recorder alarm input that requires a normally open alarm input.
- N.C.** Normally Close alarm relay output. This can be connected to a VCR or time-lapse recorder alarm input that requires a normally close alarm input.
- COM** COMMON Alarm relay output. This can be connected to a VCR or time-lapse recorder alarm common port.

Alarm Setup

Typical Alarm Configuration Diagram

Alarm Input Type

The M80CE/BE allows connection to only normally open type alarm devices.

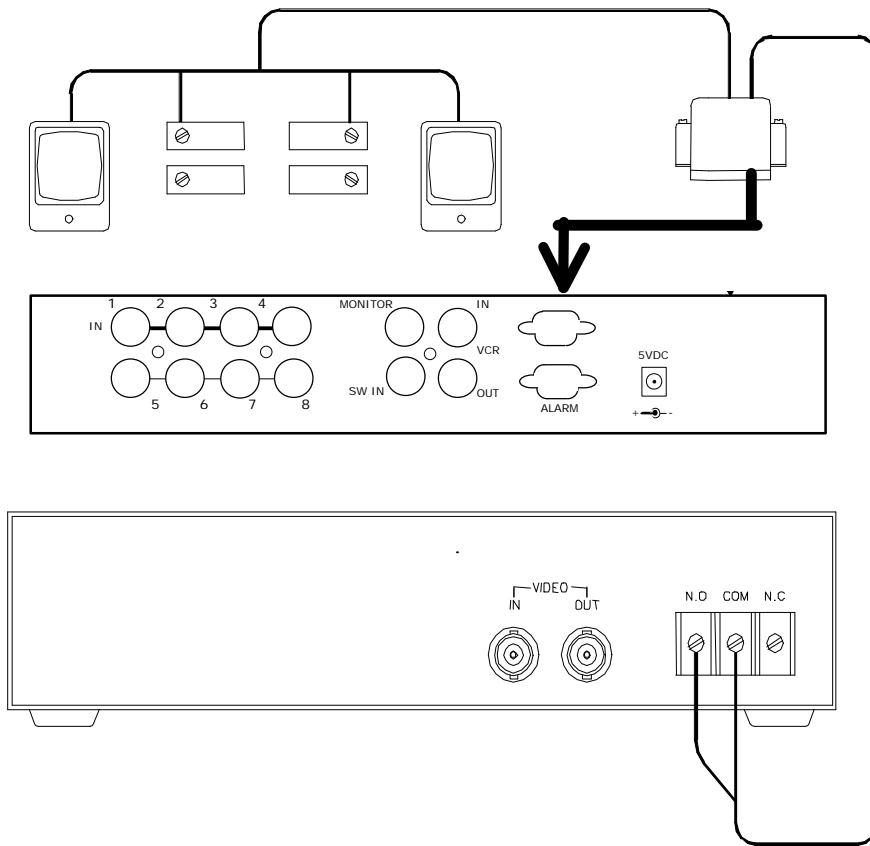

Specifications

Video Inputs

Video Standards Signals

Video Inputs
VCR Input

NTSC or PAL (depending on model)
Composite, 1.0V P-P, 75 ohms terminated
Composite, 1.0V P-P, 75 ohms terminated

Video Outputs

Video Standards Signals

Main Monitor
VCR Output

NTSC or PAL (depending on model)
Composite, 1.0V P-P
Composite, 1.0V P-P

Video Processing

Video Formats

Video Decoding
& Encoding

NTSC CCIR601 (858x525 native res.)
PAL CCIR601 (864x625 native res.)

Onscreen Display

Camera Identification Date/Time

User selectable, 8-characters per camera
5 date formats, 3 time formats

Switcher Dwell Time

Individually controlled (0-60 sec per camera)
Roll-free switching without ext sync cameras

Alarm Processing

Inputs Outputs

Normally Open Type Alarm Sensors
Relay, Normally Open or Close
1.0A Max @24V Resistive
or 0.25A Max @120/240VAC Resistive

Power

Rating AC/DC Adapter

5 VDC, 3A
Input: 100 - 264 V AC, 50/60Hz
Output: 5VDC, 3A

Dimension

10.5"(w) x 7.0"(d) x 1.6"(h)

*Specifications are subject to change without notice.